



Food Processor
TrinityPro CUTTER MIXER 2.7 QT
TRANSPARENT COPOLYESTER BOWL
1800 RPM USA PLUG

ITEM # _____

MODEL # _____

NAME # _____

SIS # _____

AIA # _____



600991 (K26PUS)

Cutter Mixer 2.7 qt with transparent copolyester bowl, 1800 rpm, USA plug

Short Form Specification

Item No. _____

Table top Cutter Mixer. 2.7 qt., transparent copolyester with scraper and central feed hole for adding products in mid-cycle. Transparent copolyester lid. Microtoothed blade rotor. Angled blades and conical base of the bowl ensure consistent mixing. All ingredients are processed evenly and quickly thanks to a special flow generated inside the bowl. No-volt release system prevents accidental start of the appliance. All parts in contact with food are removable and Dishwasher safe. Watertight, easy to clean, flat, soft-touch buttons. Single speed 1800 rpm with on/pulse/off function for simple operations. With US plug.

Main Features

- Tabletop cutter mixer and emulsifier allowing fast chopping, mixing, mincing, griding, liquidizing and kneading.
- Bowl/lid scraper included for uniform smooth results (emulsifying) and continuous working.
- Transparent lid, with funnel shaped hole, to add ingredients during use.
- All ingredients are processed evenly and quickly thanks to a special movement generated inside the bowl.
- Easy to clean and watertight control panel with on/off button and pulse function.
- Pulse function to coarse chopping.
- All parts in contact with food are removable without the use of tools, completely dismountable and dishwasher safe.
- ErgoCert 4-star certification for ergonomic design and ease of use.
- Productivity up to 50 settings per service.
- Includes 2.7 quart transparent bowl with micro-toothed blades rotor.

Construction

- Microtoothed blades in 420 AISI stainless steel and ergonomic scraper in high resistant composite material to ensure consistent mixing.
- compact design, easy to move and store.
- IPX5 (IP55) flat panel touch-control, watertight panel.
- Main switch ON/OFF on the back of the appliance.
- Asynchronous industrial motor with no brushes for high reliability and quiet functioning, stainless steel motor shaft.
- Food safety assured thanks to BPA-free materials and compliance with NSF standards.
- Product safety in accordance with international and UL standards.
- 1 speed: 1800 rpm.
- Motor power: 1 HP/ 750 Watt.
- Bowl in BPA-free, transparent copolyester.

APPROVAL: _____



Experience the Excellence
www.electroluxprofessional.com
foodservice@electrolux.com

Included Accessories

- 1 of TRANSPARENT LID FOR 2.7 QT CUTTER MIXER BOWL PNC 650117
- 1 of FINE SERRATED BLADE ROTOR FOR 2.7QT CUTTER MIXER PNC 650226
- 1 of TRANSPARENT COPOLYESTER BOWL FOR 2.7QT CUTTER MIXER PNC 650229
- 1 of SCRAPER FOR 2.7QT CUTTER MIXER BOWL PNC 650230

Optional Accessories

- TRANSPARENT LID FOR 2.7 QT CUTTER MIXER BOWL PNC 650117
- FINE SERRATED BLADE ROTOR FOR 2.7QT CUTTER MIXER PNC 650226
- SMOOTH BLADE ROTOR FOR 2.7QT CUTTER MIXER PNC 650227
- STAINLESS STEEL BOWL FOR 2.7QT CUTTER MIXER PNC 650228
- TRANSPARENT COPOLYESTER BOWL FOR 2.7QT CUTTER MIXER PNC 650229
- SCRAPER FOR 2.7QT CUTTER MIXER BOWL PNC 650230
- STAINLESS STEEL BOWL FOR 2.7QT CUTTER MIXER, FINE SERRATED ROTOR, LID WITH SCRAPER PNC 650231

Front

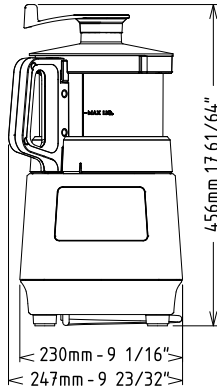

Side

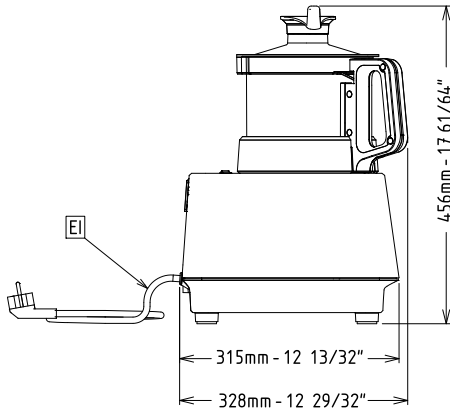

EI = Electrical connection

Top

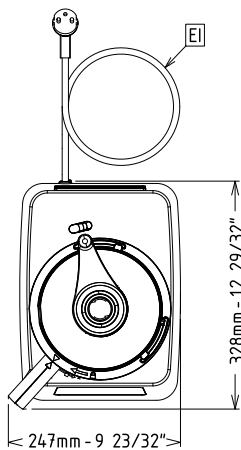
Electric
Supply voltage:

600991 (K26PUS) 115 V/1N ph/60 Hz

Electrical power, max:

0.75 kW

Total Watts:

0.75 kW

Capacity:
Performance (up to):

Capacity: 2.6 Litre

Key Information:
External dimensions, Width: 247 mm

External dimensions, Depth: 328 mm

External dimensions, Height: 456 mm

Shipping weight: 17.4 kg